

# Elfin™

## FUNNEL ENTRY

### MOLAR TUBES

by Modern Orthodontics

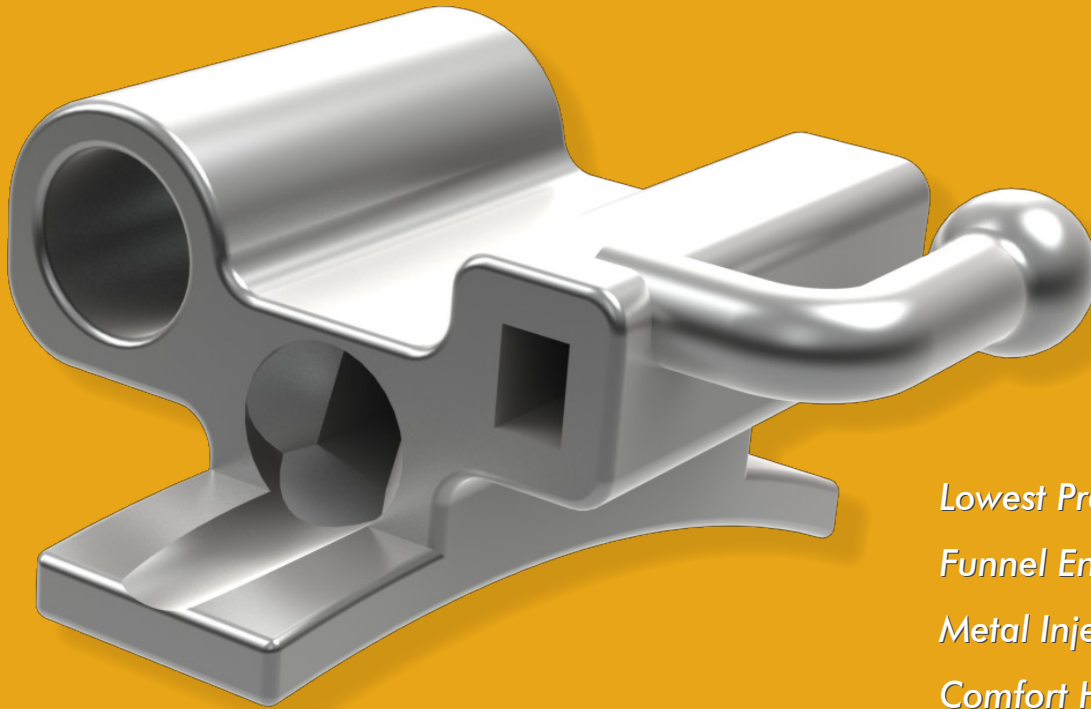

*Lowest Profile*

*Funnel Entry*

*Metal Injection Molded*

*Comfort Hooks*

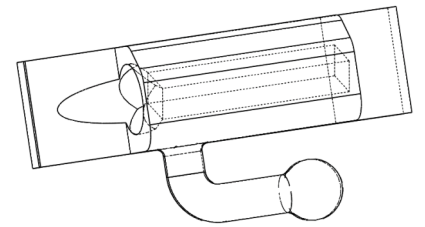
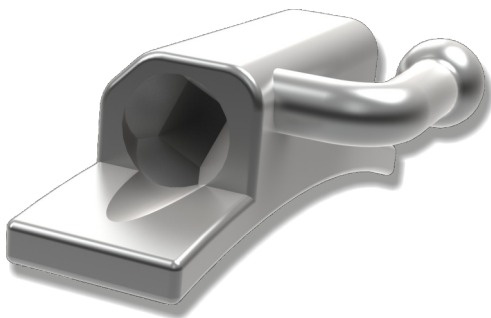

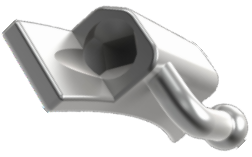

**Elfin**™  
FUNNEL ENTRY  
MINI MOLAR TUBES

Lowest Profile Design to avoid occlusal interferences and for best in-out values

Ultra Mini Size



Chamfered entry for easier wire insertion

Comfort design ball hooks

Parallel walls allow secure holding during bonding  
With any regular fine tip bonding tweezers



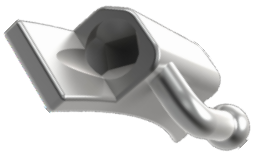

## Comparison to convertible tubes

Funneled opening for easier insertion of today's flexible wires into second molar tubes

Lower profile compared to convertible tubes

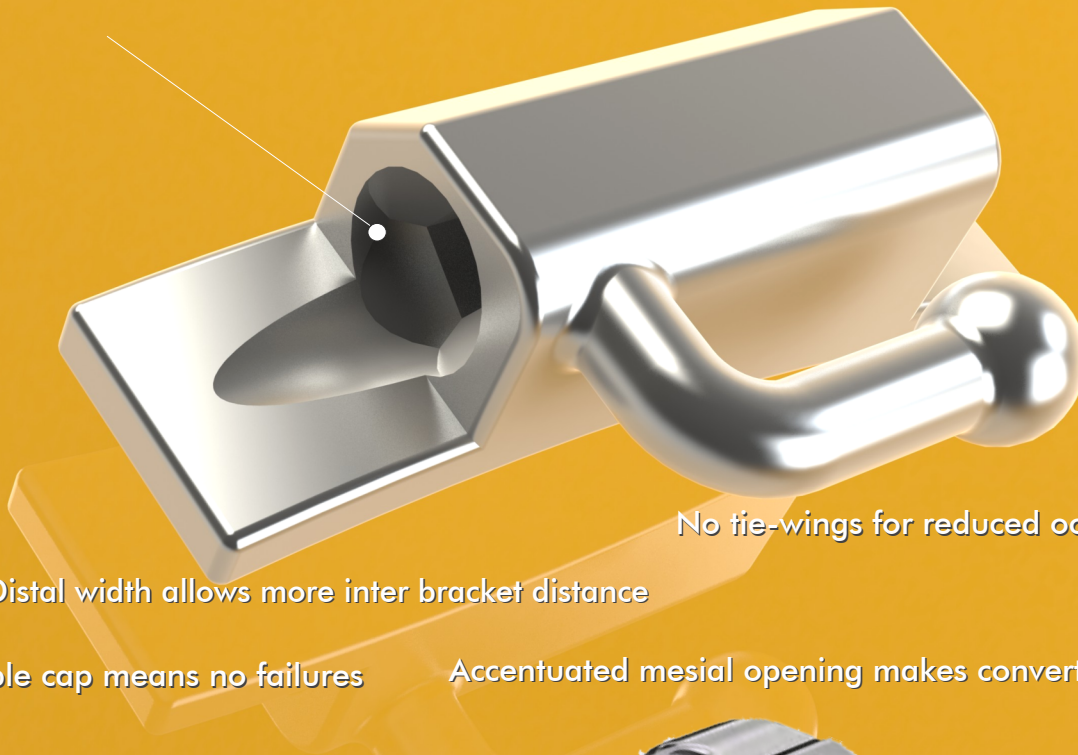

Small Mesio-Distal width allows more inter bracket distance

No tie-wings for reduced occlusal interference

No Convertible cap means no failures

Accentuated mesial opening makes convertibility unnecessary



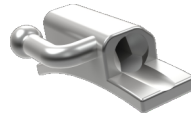
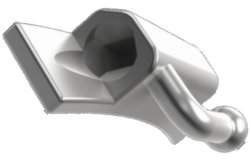

Upper single 1st molar tubes

Slot Torque	Prescription	Slot Size	Weldable		Bondable	
			Left	Right	Left	Right
-10°	Roth	.018"	MT-8W-S03	MT-8W-S02	MT-8B-S03	MT-8B-S02
-10°	Roth	.022"	MT-2W-S03	MT-2W-S02	MT-2B-S03	MT-2B-S02
-14°	MBT	.018"	MT-8W-S05	MT-8W-S04	MT-8B-S05	MT-8B-S04
-14°	MBT	.022"	MT-2W-S05	MT-2W-S04	MT-2B-S05	MT-2B-S04
Round	BEGG	.036"	MT-6W-S22	MT-6W-S21	MT-6B-S22	MT-6B-S21



Upper single 2nd molar tubes

Slot Torque	Prescription	Slot Size	Weldable		Bondable	
			Left	Right	Left	Right
-10°	Roth	.018"	MT-8W-S03	MT-8W-S02	MT-8B-S23	MT-8B-S22
-10°	Roth	.022"	MT-2W-S03	MT-2W-S02	MT-2B-S23	MT-2B-S22
-14°	MBT	.018"	MT-8W-S05	MT-8W-S04	MT-8B-S25	MT-8B-S24
-14°	MBT	.022"	MT-2W-S05	MT-2W-S04	MT-2B-S25	MT-2B-S24

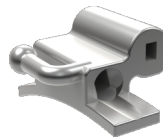

Upper double auxiliary tubes

.018"X.025" Auxiliary tube with 0° torque

Slot Torque	Prescription	Slot Size	Weldable		Bondable	
			Left	Right	Left	Right
-10°	Roth	.018"	MT-8W-D07	MT-8W-D06	MT-8B-D07	MT-8B-D06
-10°	Roth	.022"	MT-2W-D07	MT-2W-D06	MT-2B-D07	MT-2B-D06
-14°	MBT	.018"	MT-8W-D09	MT-8W-D08	MT-8B-D09	MT-8B-D08
-14°	MBT	.022"	MT-2W-D09	MT-2W-D08	MT-2B-D09	MT-2B-D08



Upper double headgear tubes

.045" Occlusal headgear tube

Slot Torque	Prescription	Slot Size	Weldable		Bondable	
			Left	Right	Left	Right
-10°	Roth	.018"	MT-8W-D03	MT-8W-D02	MT-8B-D03	MT-8B-D02
-10°	Roth	.022"	MT-2W-D03	MT-2W-D02	MT-2B-D03	MT-2B-D02
-14°	MBT	.018"	MT-8W-D05	MT-8W-D04	MT-8B-D05	MT-8B-D04
-14°	MBT	.022"	MT-2W-D05	MT-2W-D04	MT-2B-D05	MT-2B-D04

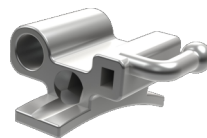

Upper triple tubes

.018"X.025" Auxiliary tube with 0° torque

.045" Occlusal headgear tube

Slot Torque	Prescription	Slot Size	Weldable		Bondable	
			Left	Right	Left	Right
-10°	Roth	.018"	MT-8W-T03	MT-8W-T02	MT-8B-T03	MT-8B-T02
-10°	Roth	.022"	MT-2W-T03	MT-2W-T02	MT-2B-T03	MT-2B-T02
-14°	MBT	.018"	MT-8W-T05	MT-8W-T04	MT-8B-T05	MT-8B-T04
-14°	MBT	.022"	MT-2W-T05	MT-2W-T04	MT-2B-T05	MT-2B-T04



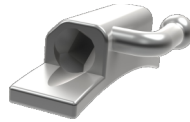
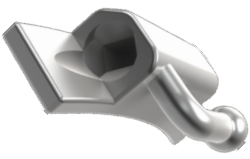

Lower single 1st molar tubes

Slot Torque	Prescription	Slot Size	Weldable		Bondable	
			Left	Right	Left	Right
-25°	Roth	.018"	MT-8W-S07	MT-8W-S06	MT-8B-S07	MT-8B-S06
-25°	Roth	.022"	MT-2W-S07	MT-2W-S06	MT-2B-S07	MT-2B-S06
-20°	MBT	.018"	MT-8W-S09	MT-8W-S08	MT-8B-S09	MT-8B-S08
-20°	MBT	.022"	MT-2W-S09	MT-2W-S08	MT-2B-S09	MT-2B-S08
-	BEGG	.036"	MT-6W-S24	MT-6W-S23	MT-6B-S24	MT-6B-S23

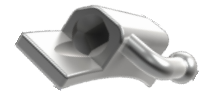

Lower single 2nd molar tubes

Slot Torque	Prescription	Slot Size	Weldable		Bondable	
			Left	Right	Left	Right
-25°	Roth	.018"	MT-8W-S27	MT-8W-S26	MT-8B-S27	MT-8B-S26
-25°	Roth	.022"	MT-2W-S27	MT-2W-S26	MT-2B-S27	MT-2B-S26
-10°	MBT	.018"	MT-8W-S29	MT-8W-S28	MT-8B-S29	MT-8B-S28
-10°	MBT	.022"	MT-2W-S29	MT-2W-S28	MT-2B-S29	MT-2B-S28

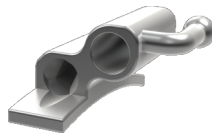

Lower double lip bumper tubes

.045" Gingival lip bumper tube

Slot Torque	Prescription	Slot Size	Weldable		Bondable	
			Left	Right	Left	Right
-25°	Roth	.018"	MT-8W-D11	MT-8W-D10	MT-8B-D11	MT-8B-D10
-25°	Roth	.022"	MT-2W-D11	MT-2W-D10	MT-2B-D11	MT-2B-D10
-20°	MBT	.018"	MT-8W-D13	MT-8W-D12	MT-8B-D13	MT-8B-D12
-20°	MBT	.022"	MT-2W-D13	MT-2W-D12	MT-2B-D13	MT-2B-D12

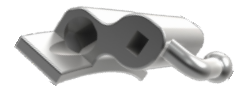

Lower double auxiliary tubes

.018"X.025" Auxiliary tube with 0 torque

Slot Torque	Prescription	Slot Size	Weldable		Bondable	
			Left	Right	Left	Right
-25°	Roth	.018"	MT-8W-D15	MT-8W-D14	MT-8B-D15	MT-8B-D14
-25°	Roth	.022"	MT-2W-D15	MT-2W-D14	MT-2B-D15	MT-2B-D14
-20°	MBT	.018"	MT-8W-D17	MT-8W-D16	MT-8B-D17	MT-8B-D16
-20°	MBT	.022"	MT-2W-D17	MT-2W-D16	MT-2B-D17	MT-2B-D16

Convenient 5 patient packs on next page

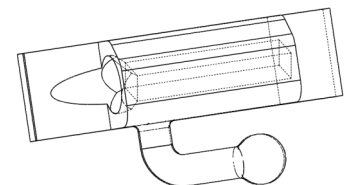

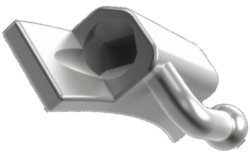

**Elfin**™

FUNNEL ENTRY  
MINI MOLAR TUBES

5 patient pack Roth .018" 1st molar tubes

Prescription	Slot Size	Weldable		Cat. No.	Slot Size	Bondable		Cat. No.
		Upper	Lower			Upper	Lower	
Roth	.018"	Single	Single	MT-8W-K01	.018"	Single	Single	MT-8B-K01
Roth	.018"	Double Headgear	Single	MT-8W-K02	.018"	Double Headgear	Single	MT-8B-K02
Roth	.018"	Double Auxillary	Single	MT-8W-K03	.018"	Double Auxillary	Single	MT-8B-K03
Roth	.018"	Triple	Double Auxillary	MT-8W-K04	.018"	Triple	Double Auxillary	MT-8B-K04
Roth	.018"	Triple	Double Lip-bumper	MT-8W-K05	.018"	Triple	Double Lipbumper	MT-8B-K05



5 patient pack Roth .022" 1st molar tubes

Prescription	Slot Size	Weldable		Cat. No.	Slot Size	Bondable		Cat. No.
		Upper	Lower			Upper	Lower	
Roth	.022"	Single	Single	MT-2W-K01	.022"	Single	Single	MT-2B-K01
Roth	.022"	Double Headgear	Single	MT-2W-K02	.022"	Double Headgear	Single	MT-2B-K02
Roth	.022"	Double Auxillary	Single	MT-2W-K03	.022"	Double Auxillary	Single	MT-2B-K03
Roth	.022"	Triple	Double Auxillary	MT-2W-K04	.022"	Triple	Double Auxillary	MT-2B-K04
Roth	.022"	Triple	Double Lip-bumper	MT-2W-K05	.022"	Triple	Double Lipbumper	MT-2B-K05

5 patient pack MBT .018" 1st molar tubes

Prescription	Slot Size	Weldable		Cat. No.	Slot Size	Bondable		Cat. No.
		Upper	Lower			Upper	Lower	
MBT	.018"	Single	Single	MT-8W-K11	.018"	Single	Single	MT-8B-K11
MBT	.018"	Double Headgear	Single	MT-8W-K12	.018"	Double Headgear	Single	MT-8B-K12
MBT	.018"	Double Auxillary	Single	MT-8W-K13	.018"	Double Auxillary	Single	MT-8B-K13
MBT	.018"	Triple	Double Auxillary	MT-8W-K14	.018"	Triple	Double Auxillary	MT-8B-K14
MBT	.018"	Triple	Double Lip-bumper	MT-8W-K15	.018"	Triple	Double Lipbumper	MT-8B-K15

5 patient pack MBT .022" 1st molar tubes

Prescription	Slot Size	Weldable		Cat. No.	Slot Size	Bondable		Cat. No.
		Upper	Lower			Upper	Lower	
MBT	.022"	Single	Single	MT-2W-K11	.022"	Single	Single	MT-2B-K11
MBT	.022"	Double Headgear	Single	MT-2W-K12	.022"	Double Headgear	Single	MT-2B-K12
MBT	.022"	Double Auxillary	Single	MT-2W-K13	.022"	Double Auxillary	Single	MT-2B-K13
MBT	.022"	Triple	Double Auxillary	MT-2W-K14	.022"	Triple	Double Auxillary	MT-2B-K14
MBT	.022"	Triple	Double Lipbumper	MT-2W-K15	.022"	Triple	Double Lipbumper	MT-2B-K15

5 patient pack 2nd molar tubes

Prescription	Slot Size	Weldable		Cat. No.	Slot Size	Bondable		Cat. No.
		Upper	Lower			Upper	Lower	
Roth	.018"	Single	Single	MT-8W-K21	.018"	Single	Single	MT-8B-K21
Roth	.022"	Single	Single	MT-2W-K21	.022"	Single	Single	MT-2B-K21
MBT	.018"	Single	Single	MT-8W-K22	.018"	Single	Single	MT-8B-K22
MBT	.022"	Single	Single	MT-2W-K22	.022"	Single	Single	MT-2B-K22



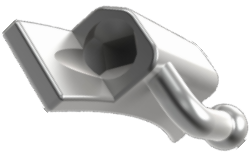

**Elfin**™  
FUNNEL ENTRY  
MINI MOLAR TUBES



Lingual Button  
Weldable  
Cat.no. ALU-LB-001



Weldable Sheath  
Cat.no. ALU-LS-001



Weldable Cleat  
Cat.no. ALU-LC-001

Bondable  
Lingual  
Cleat  
Cat.no. ALU-LC-002  
10 per pack



Direct Bond  
Lingual Buttons  
Round Base  
Cat.no. ALU-LB-002  
10 per pack



Weldable  
Lingual  
Cleat  
Cat.no. ALU-LC-001  
10 per pack



Lingual  
Sheath  
Cat.no. ALU-LS-001  
10 per pack

